

Model: L-424
Capacity: 4,000 Pounds
Raised Height: 45"
Lowered Height: 27"
Travel: 18"
Deck: 24" Sq. Welded Steel Deck, 360° Continuous Rotation with Brake Handle
Base: 24" Sq., Formed Steel Legs, Welded Steel Frame, 2x Each Ø5" Cast Iron Rigid & Swivel Casters, 1x Foot Actuated Floor Brake
Power: Manual Powered Foot Pump
Controls: Foot Pedals – Lift/Lower
Paint: Lange Lift Shadow Gray

Email sales@langelift.com for all modification requirements

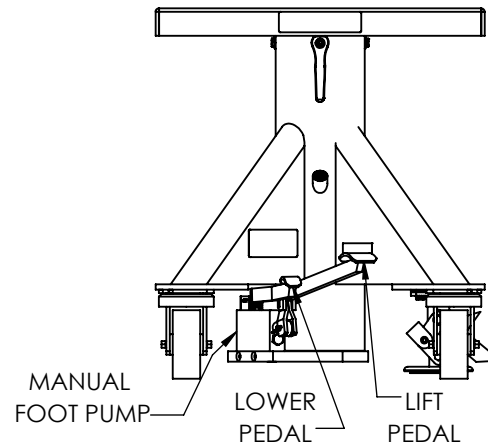

DECK ROTATION
BRAKE HANDLE

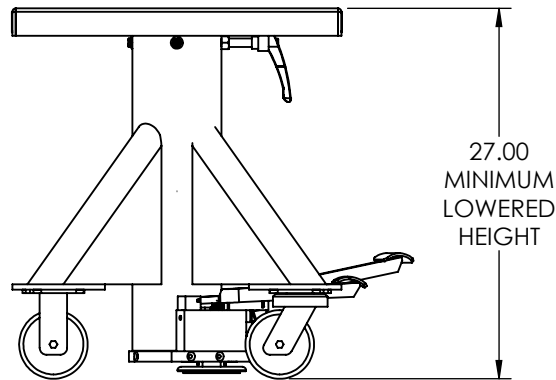
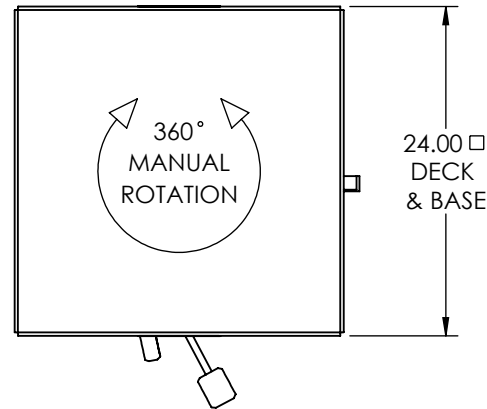
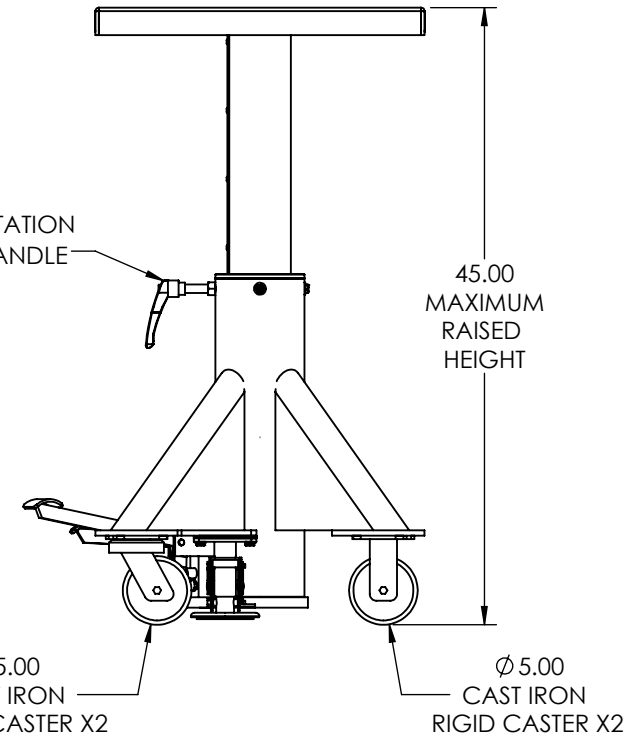

PROPRIETARY AND CONFIDENTIAL, THE INFORMATION CONTAINED IN THIS DRAWING IS THE SOLE PROPERTY OF LANGE LIFT. ANY REPRODUCTION IN PART OR AS A WHOLE WITHOUT THE WRITTEN PERMISSION OF LANGE LIFT IS PROHIBITED.

DIMENSIONS ARE IN INCHES		DESCRIPTION:		REV:
THIRD ANGLE		L-424 - Specification Sheet		-
PROJECTION	SCALE:	DRAWN BY:	DATE:	DWG NO:
	NTS	DMK	12/7/2021	L-424
				SHEET:
				1 OF 1