

Model: L-330

Capacity: 3,000 Pounds

Raised Height: 45"

Lowered Height: 27"

Travel: 18"

Deck: 30" Sq. Welded Steel Deck, 360° Continuous Rotation with Brake Handle

Base: 30" Sq., Formed Steel Legs, Welded Steel Frame, 2x Each Ø5" Cast Iron Rigid & Swivel Casters, 1x Foot Actuated Floor Brake

Power: Manual Powered Foot Pump

Controls: Foot Pedals – Lift/Lower

Paint: Lange Lift Shadow Gray

Email sales@langelift.com for all modification requirements

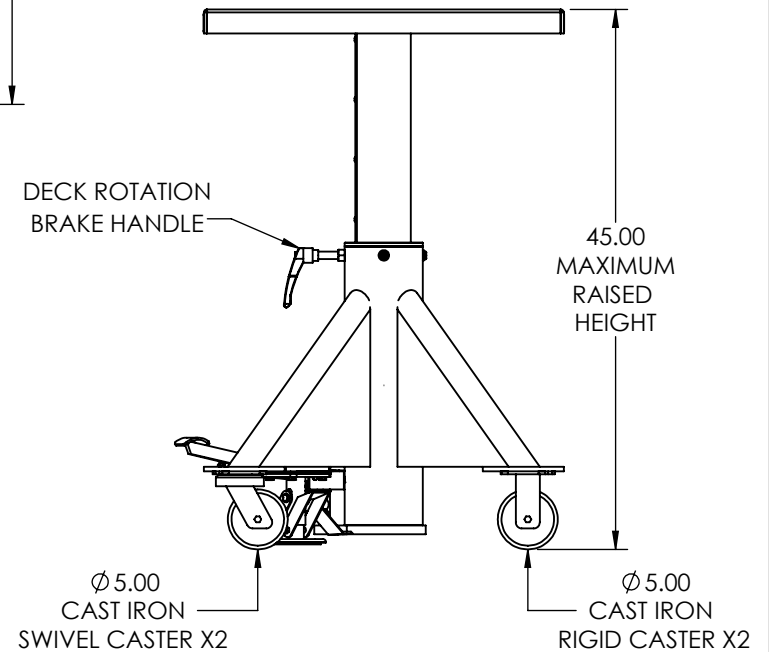
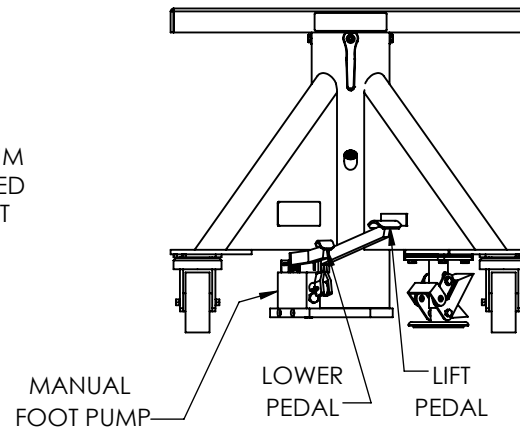
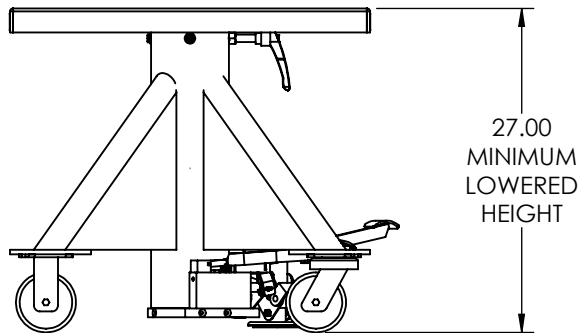
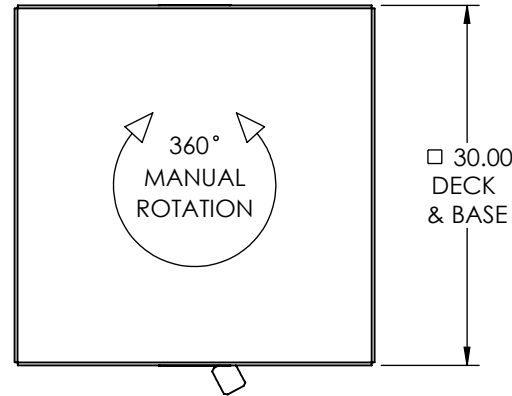
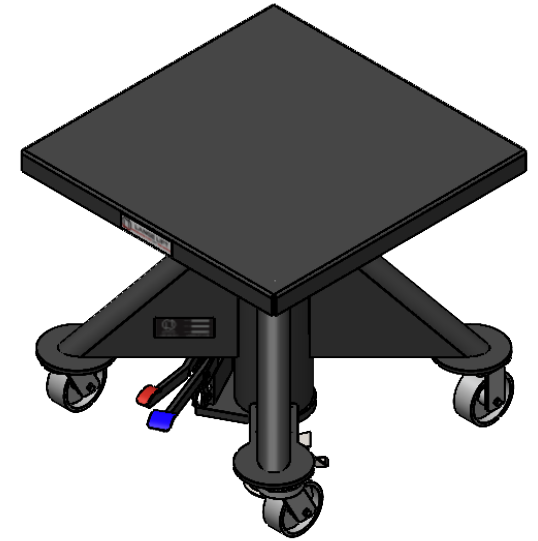

PO Box 580 Menomonee Falls, WI 53052
Phone (262) 502-0333 | langelift.com

PROPRIETARY AND CONFIDENTIAL, THE INFORMATION CONTAINED IN THIS DRAWING IS THE SOLE PROPERTY OF LANGE LIFT. ANY REPRODUCTION IN PART OR AS A WHOLE WITHOUT THE WRITTEN PERMISSION OF LANGE LIFT IS PROHIBITED.

DIMENSIONS ARE IN INCHES		THIRD ANGLE PROJECTION		DESCRIPTION:		REV:
L-330 - Specification Sheet						-
SCALE:	DRAWN BY:	DATE:	DWG NO:	SHEET:		
NTS	DMK	12/7/2021	L-330	1 OF 1		