

MODEL: L-536-AP
CAPACITY: 5,000 Pounds
RAISED HEIGHT: 45.00
LOWERED HEIGHT: 27.00
TRAVEL: 18.00
DECK: 36" Square, Formed & Welded Flat Steel Deck, 360° Continuous Rotation with Lock Handle
BASE: 36" Square, Formed Steel Legs and Welded Steel Frame. Features 5" Ø Drop Forged Rigid and Swivel Casters and a Foot Actuated Floor Lock.
POWER: Air Motor – 80 PSI @ 50 CFM (Recommended), On Board Air Regulator, Filter, and Lubricator
CONTROLS: Air Valve Pedal – Up/Down
PAINT: Machine Green

Components and locations are subject to change without notice. This is based on, but not limited to, availability, supplier quality, and product improvements

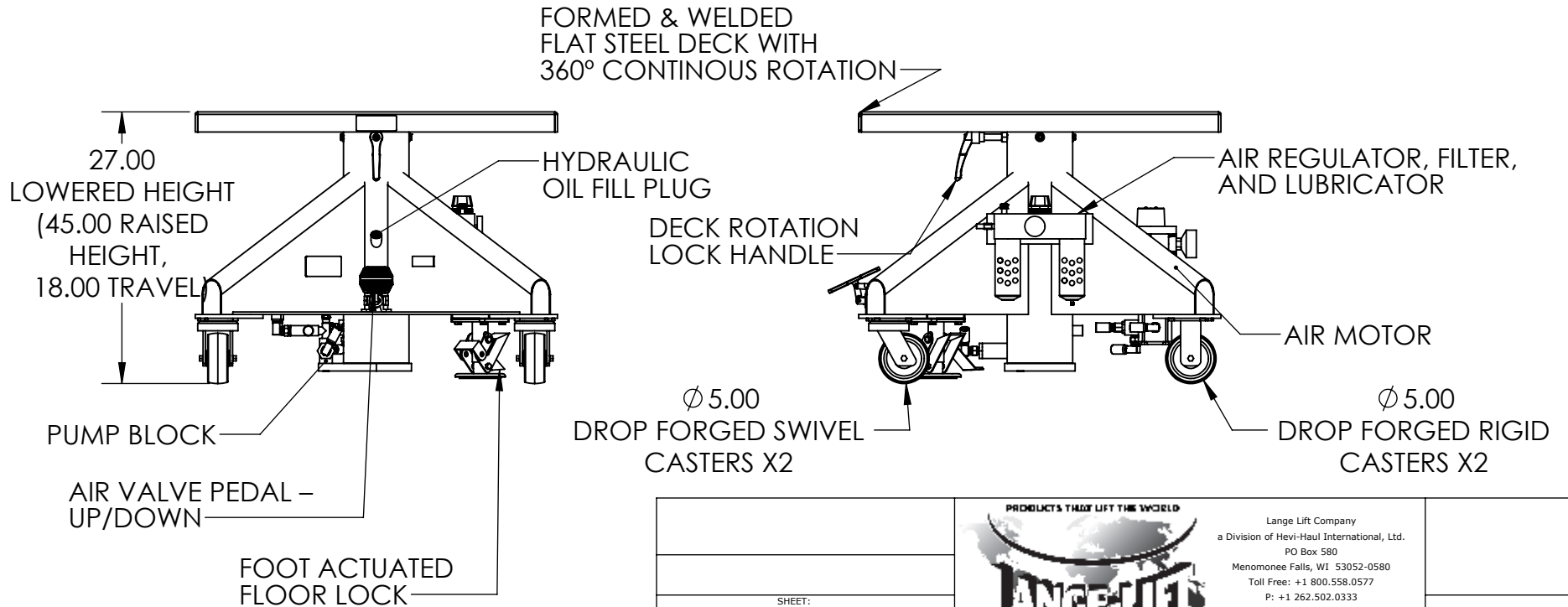

SHEET: 1 of 1				Lange Lift Company a Division of Hevi-Haul International, Ltd. PO Box 580 Menomonee Falls, WI 53052-0580 Toll Free: +1 800.558.0577 P: +1 262.502.0333 F: +1 262.502.0260 E-Mail: sales@langelift.com		DIMENSIONS ARE IN INCHES	
				DRAWN BY: DMK			CHECKED BY:
PROPRIETARY AND CONFIDENTIAL THE INFORMATION CONTAINED IN THIS DRAWING IS THE SOLE PROPERTY OF LANGE LIFT. ANY REPRODUCTION IN PART OR AS A WHOLE WITHOUT THE WRITTEN PERMISSION OF LANGE LIFT IS PROHIBITED		TITLE: L-536-AP - Specification Sheet				REVISION:	
SCALE: 1:16		DRAWING NUMBER: L-536-AP					