

**MODEL:** L-424-EP  
**CAPACITY:** 4,000 Pounds  
**RAISED HEIGHT:** 45.00  
**LOWERED HEIGHT:** 27.00  
**TRAVEL:** 18.00

**DECK:** 24" Square, Formed & Welded Flat Steel Deck, 360° Continuous Rotation with Lock Handle

**BASE:** 24" Square, Formed Steel Legs and Welded Steel Frame. Features 5" Ø Cast Iron Rigid and Swivel Casters and a Foot Actuated Floor Lock.

**POWER:** 120V AC Electric over Hydraulic Motor

**CONTROLS:** Guarded Dual Foot Switch – Up/Down

**PAINT:** Machine Green

Components and locations are subject to change without notice. This is based on, but not limited to, availability, supplier quality, and product improvements

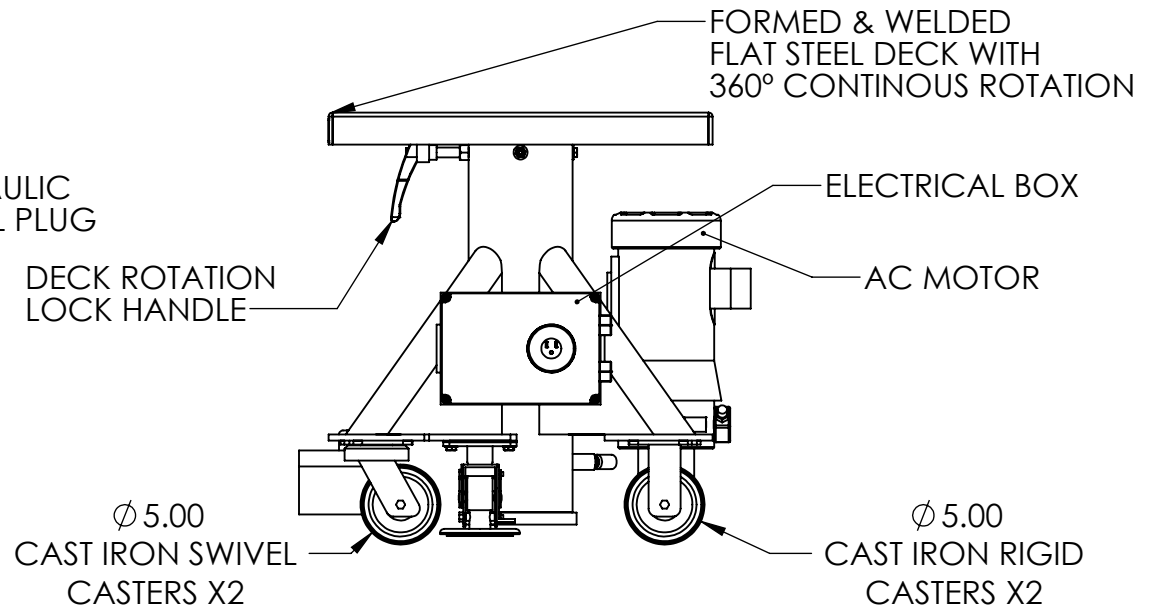
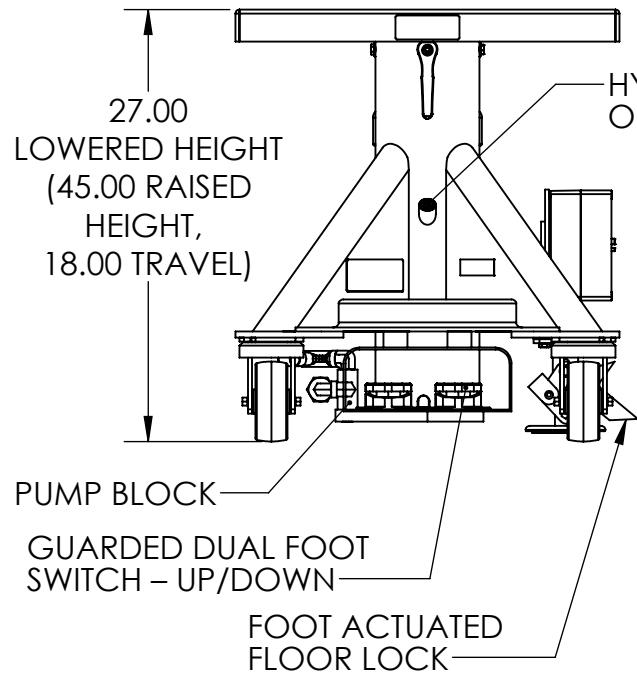

SHEET: 1 of 1		 <p>PRODUCTS THAT LIFT THE WORLD</p> <p>Lange Lift Company a Division of Hevi-Haul International, Ltd. PO Box 580 Menomonee Falls, WI 53052-0580 Toll Free: +1 800.558.0577 P: +1 262.502.0333 F: +1 262.502.0260 E-Mail: sales@langelift.com</p>		DIMENSIONS ARE IN INCHES	
				DATE: 9/28/2016	
<b>PROPRIETARY AND CONFIDENTIAL</b>  THE INFORMATION CONTAINED IN THIS DRAWING IS THE SOLE PROPERTY OF LANGE LIFT. ANY REPRODUCTION IN PART OR AS A WHOLE WITHOUT THE WRITTEN PERMISSION OF LANGE LIFT IS PROHIBITED		DRAWN BY: DMK	CHECKED BY:		
		TITLE: L-424-EP - Specification Sheet			
		SCALE: 1:12	DRAWING NUMBER: L-424-EP	REVISION:	