

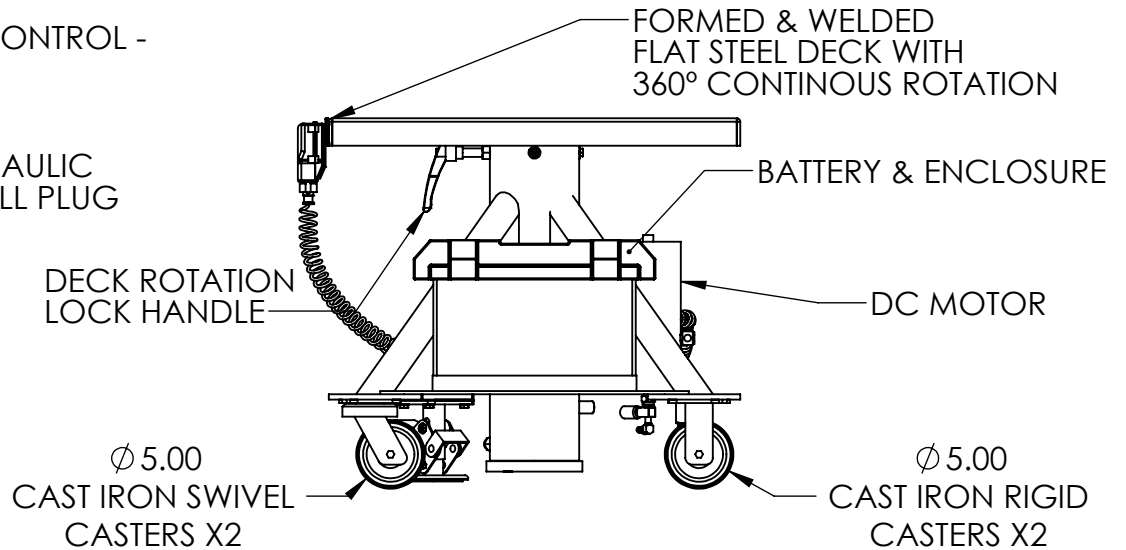

MODEL: L-430-BP
CAPACITY: 4,000 Pounds
RAISED HEIGHT: 45.00, **LOWERED HEIGHT:** 27.00, **TRAVEL:** 18.00
DECK: 30" Square, Formed & Welded Flat Steel Deck, 360° Continuous Rotation with Lock Handle
BASE: 30" Square, Formed Steel Legs and Welded Steel Frame. Features 5" Ø Cast Iron Rigid and Swivel Casters and a Foot Actuated Floor Lock.
POWER: 12V Deep Cycle Battery (Enclosed), DC Motor, and On Board Battery Charger
CONTROLS: Push Button Coil Corded Pendant Control – Up/Down
PAINT: Machine Green

Components and locations are subject to change without notice. This is based on, but not limited to, availability, supplier quality, and product improvements

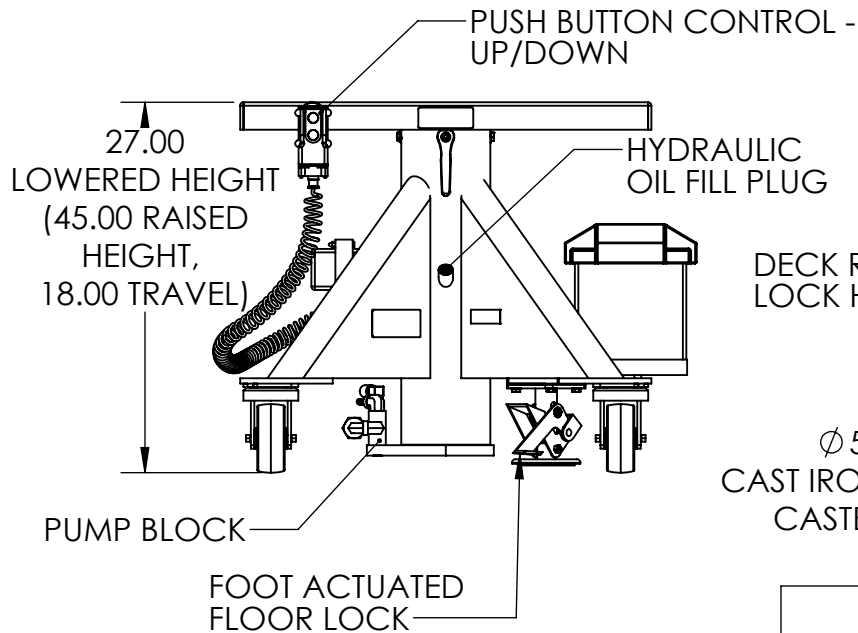

SHEET: 1 of 1		PRODUCTS THAT LIFT THE WORLD  A DIVISION OF HEVI-HAUL INTERNATIONAL LTD.		Lange Lift Company a Division of Hevi-Haul International, Ltd. PO Box 580 Menomonee Falls, WI 53052-0580 Toll Free: +1 800.558.0577 P: +1 262.502.0333 F: +1 262.502.0260 E-Mail: sales@langelift.com	DIMENSIONS ARE IN INCHES
		PROPRIETARY AND CONFIDENTIAL THE INFORMATION CONTAINED IN THIS DRAWING IS THE SOLE PROPERTY OF LANGE LIFT. ANY REPRODUCTION IN PART OR AS A WHOLE WITHOUT THE WRITTEN PERMISSION OF LANGE LIFT IS PROHIBITED	DRAWN BY: DMK	CHECKED BY:	DATE: 9/28/2016
TITLE: L-430-BP - Specification Sheet		SCALE: 1:14	DRAWING NUMBER: L-430-BP	REVISION:	