

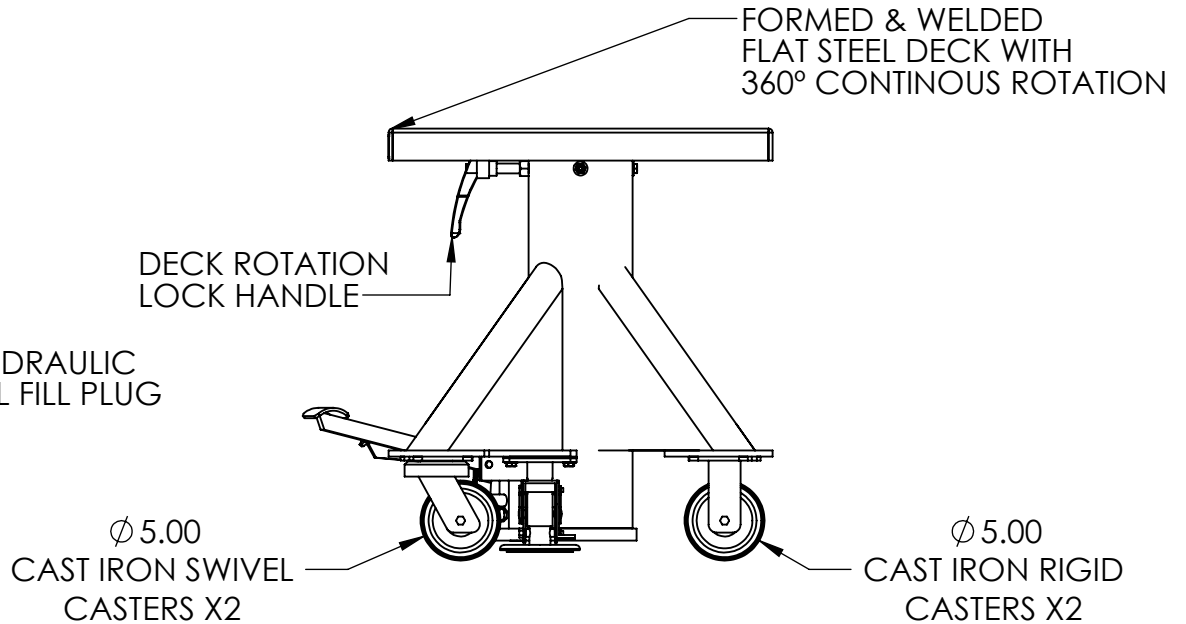

MODEL: L-324
CAPACITY: 3,000 Pounds
RAISED HEIGHT: 45.00
LOWERED HEIGHT: 27.00
TRAVEL: 18.00
DECK: 24" Square, Formed & Welded Flat Steel Deck, 360 Degree Continuous Rotation with Lock Handle
BASE: 24" Square, Formed Steel Legs and Welded Steel Frame. Features 5" Ø Cast Iron Rigid and Swivel Casters and a Foot Actuated Floor Lock
POWER: Manual Powered Foot Pump
CONTROLS: Foot Pedals – Up/Down
PAINT: Machine Green

Components and locations are subject to change without notice. This is based on, but not limited to, availability, supplier quality, and product improvement

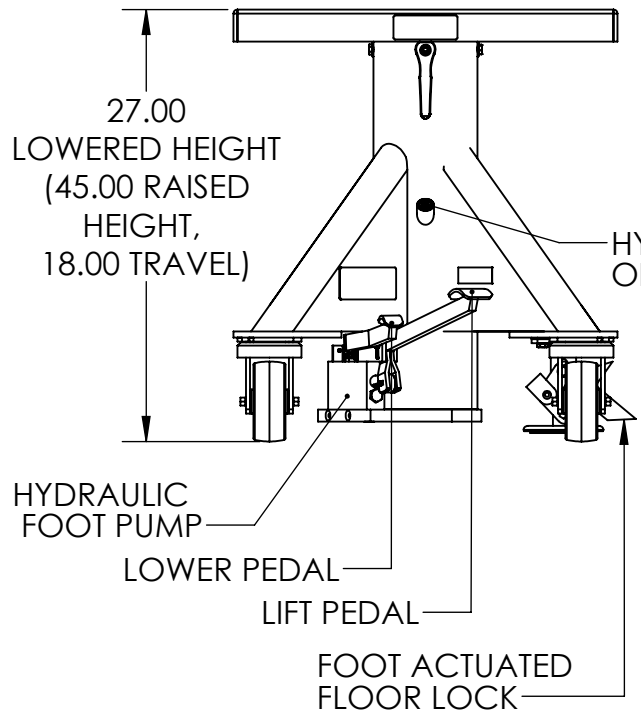

SHEET: 1 of 1		PRODUCTS THAT LIFT THE WORLD  A DIVISION OF HEVI-HAUL INTERNATIONAL, LTD.		Lange Lift Company a Division of Hevi-Haul International, Ltd. PO Box 580 Menomonee Falls, WI 53052-0580 Toll Free: +1 800.558.0577 P: +1 262.502.0333 F: +1 262.502.0260 E-Mail: sales@langelift.com		DIMENSIONS ARE IN INCHES	
		PROPRIETARY AND CONFIDENTIAL THE INFORMATION CONTAINED IN THIS DRAWING IS THE SOLE PROPERTY OF LANGE LIFT. ANY REPRODUCTION IN PART OR AS A WHOLE WITHOUT THE WRITTEN PERMISSION OF LANGE LIFT IS PROHIBITED		DRAWN BY: DMK TITLE: L-324 - Specification Sheet		CHECKED BY:	
SCALE: 1:12		DRAWING NUMBER: L-324		REVISION:			