

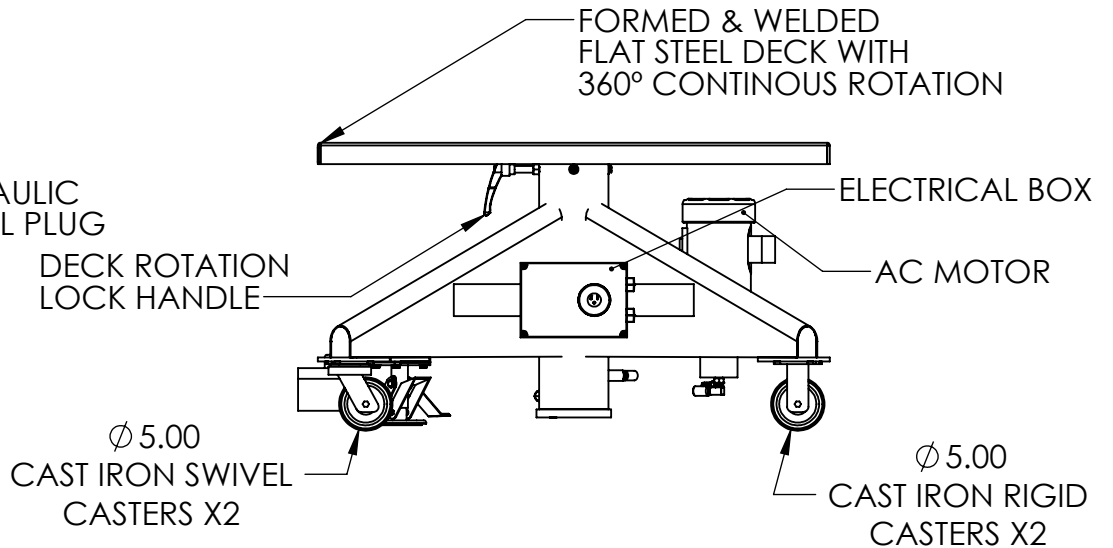

**MODEL:** L-348-EP  
**CAPACITY:** 3,000 Pounds  
**RAISED HEIGHT:** 45.00  
**LOWERED HEIGHT:** 27.00  
**TRAVEL:** 18.00  
**DECK:** 48" Square, Formed & Welded Flat Steel Deck, 360° Continuous Rotation with Lock Handle  
**BASE:** 48" Square, Formed Steel Legs and Welded Steel Frame. Features 5" Ø Cast Iron Rigid and Swivel Casters and a Foot Actuated Floor Lock.  
**POWER:** 120V AC Electric over Hydraulic Motor  
**CONTROLS:** Guarded Dual Foot Switch – Up/Down  
**PAINT:** Machine Green

Components and locations are subject to change without notice. This is based on, but not limited to, availability, supplier quality, and product improvements

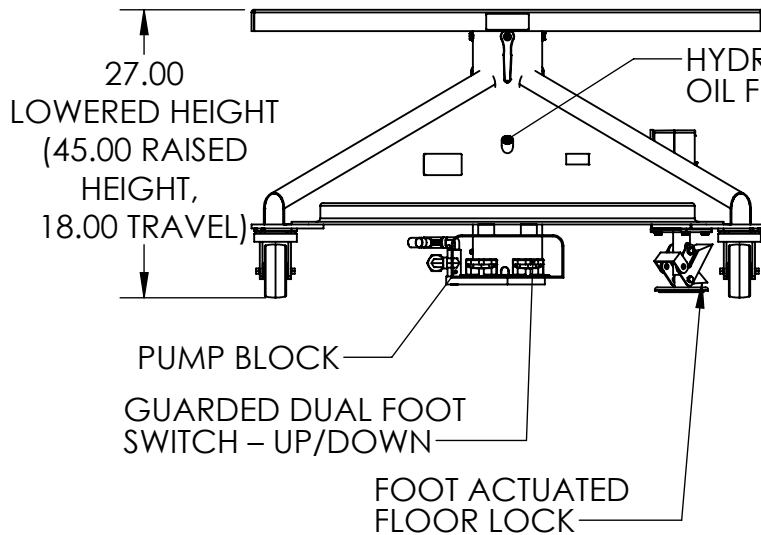

SHEET: 1 of 1		PRODUCTS THAT LIFT THE WORLD  A DIVISION OF HEVI-HAUL INTERNATIONAL LTD.		Lange Lift Company a Division of Hevi-Haul International, Ltd. PO Box 580 Menomonee Falls, WI 53052-0580 Toll Free: +1 800.558.0577 P: +1 262.502.0333 F: +1 262.502.0260 E-Mail: sales@langelift.com		DIMENSIONS ARE IN INCHES			
		PROPRIETARY AND CONFIDENTIAL  THE INFORMATION CONTAINED IN THIS DRAWING IS THE SOLE PROPERTY OF LANGE LIFT. ANY REPRODUCTION IN PART OR AS A WHOLE WITHOUT THE WRITTEN PERMISSION OF LANGE LIFT IS PROHIBITED		DRAWN BY: <b>DMK</b>		CHECKED BY:		DATE: <b>9/28/2016</b>	
TITLE: <b>L-348-EP - Specification Sheet</b>				SCALE: <b>1:18</b>		DRAWING NUMBER: <b>L-348-EP</b>		REVISION:	