

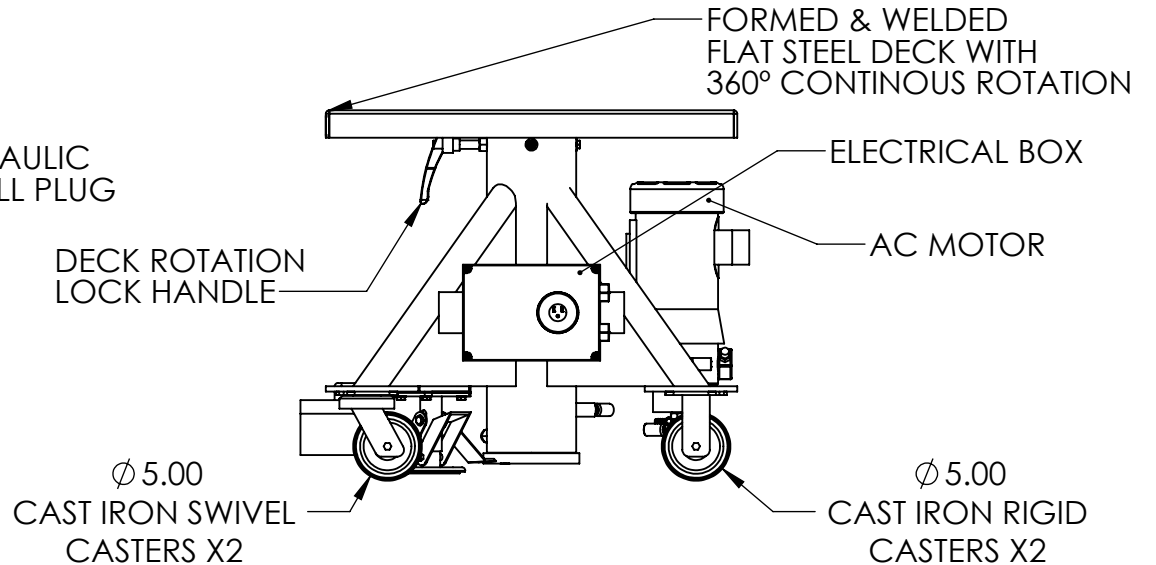

MODEL: L-330-EP
CAPACITY: 3,000 Pounds
RAISED HEIGHT: 45.00
LOWERED HEIGHT: 27.00
TRAVEL: 18.00
DECK: 30" Square, Formed & Welded Flat Steel Deck, 360° Continuous Rotation with Lock Handle
BASE: 30" Square, Formed Steel Legs and Welded Steel Frame. Features 5" Ø Cast Iron Rigid and Swivel Casters and a Foot Actuated Floor Lock.
POWER: 120V AC Electric over Hydraulic Motor
CONTROLS: Guarded Dual Foot Switch – Up/Down
PAINT: Machine Green

Components and locations are subject to change without notice. This is based on, but not limited to, availability, supplier quality, and product improvements

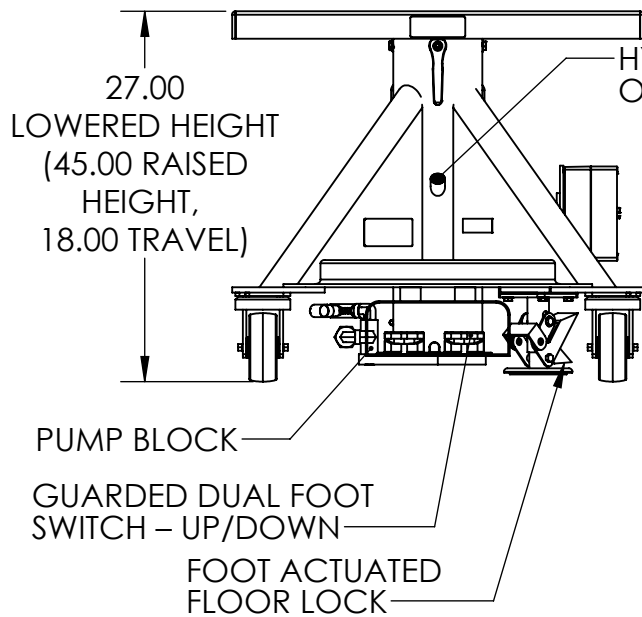

SHEET: 1 of 1		 <p>PRODUCTS THAT LIFT THE WORLD</p> <p>Lange Lift Company a Division of Hevi-Haul International, Ltd. PO Box 580 Menomonee Falls, WI 53052-0580 Toll Free: +1 800.558.0577 P: +1 262.502.0333 F: +1 262.502.0260 E-Mail: sales@langelift.com</p>		DIMENSIONS ARE IN INCHES	
				DATE: 9/28/2016	
PROPRIETARY AND CONFIDENTIAL THE INFORMATION CONTAINED IN THIS DRAWING IS THE SOLE PROPERTY OF LANGE LIFT. ANY REPRODUCTION IN PART OR AS A WHOLE WITHOUT THE WRITTEN PERMISSION OF LANGE LIFT IS PROHIBITED		DRAWN BY: DMK	CHECKED BY:	TITLE: L-330-EP - Specification Sheet	
		SCALE: 1:14	DRAWING NUMBER: L-330-EP	REVISION:	