

MODEL: L-124-BP
CAPACITY: 1,000 Pounds
RAISED HEIGHT: 45.00, **LOWERED HEIGHT:** 27.00, **TRAVEL:** 18.00
DECK: 24" Square, Formed & Welded Flat Steel Deck, 360° Continuous Rotation with Lock Handle
BASE: 24" Square, Formed Steel Legs and Welded Steel Frame. Features 5" Ø Cast Iron Rigid and Swivel Casters and a Foot Actuated Floor Lock.
POWER: 12V Deep Cycle Battery (Enclosed), DC Motor, and On Board Battery Charger
CONTROLS: Push Button Coil Corded Pendant Control – Up/Down
PAINT: Machine Green

Components and locations are subject to change without notice. This is based on, but not limited to, availability, supplier quality, and product improvements

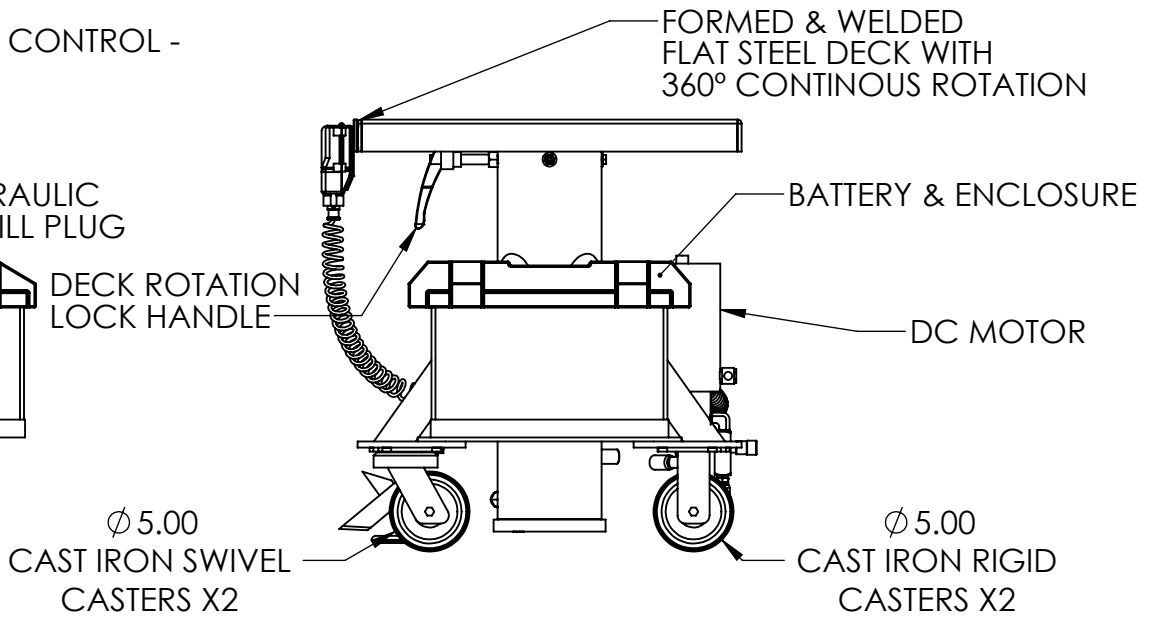
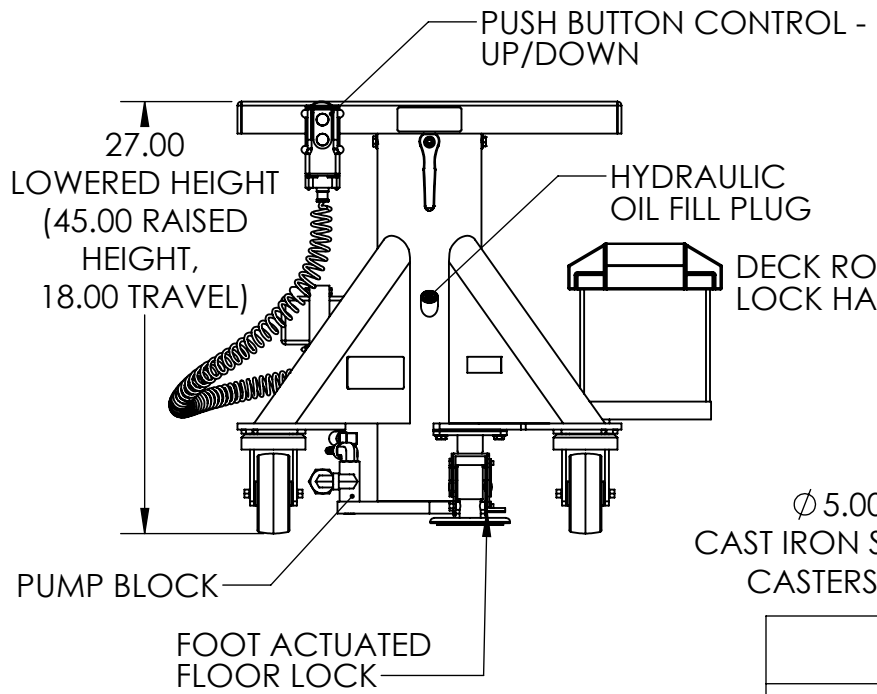

SHEET: 1 of 1				Lange Lift Company a Division of Hevi-Haul International, Ltd. PO Box 580 Menomonee Falls, WI 53052-0580 Toll Free: +1 800.558.0577 P: +1 262.502.0333 F: +1 262.502.0260 E-Mail: sales@langelift.com		DIMENSIONS ARE IN INCHES			
				DRAWN BY: DMK		CHECKED BY:		DATE: 9/28/2016	
PROPRIETARY AND CONFIDENTIAL THE INFORMATION CONTAINED IN THIS DRAWING IS THE SOLE PROPERTY OF LANGE LIFT. ANY REPRODUCTION IN PART OR AS A WHOLE WITHOUT THE WRITTEN PERMISSION OF LANGE LIFT IS PROHIBITED		TITLE: L-124-BP - Specification Sheet				SCALE: 1:12		DRAWING NUMBER: L-124-BP	
						REVISION:			