

MANUFACTURERS OF HYDRAULIC/PNEUMATIC/ELECTRIC LIFT SYSTEMS...DORWAY®

LIFTS , SCISSORS LIFTS, TIPSTERS®, IN-GROUND LIFTS, UPENDERS, DUMPERS, TILTERS, AND CUSTOM LIFT SYSTEMS!

LIFTS , SCISSORS LIFTS, TIPSTERS®, IN-GROUND LIFTS, UPENDERS, DUMPERS, TILTERS, AND CUSTOM LIFT SYSTEMS!

1-800-558-0577



**LIFTS**

PRODUCTS THAT LIFT THE WORLD



A DIVISION OF HEVI-HAUL INTERNATIONAL, LTD.

MANUFACTURERS OF HYDRAULIC/PNEUMATIC/ELECTRIC LIFT SYSTEMS...DORWAY®

# Lange Lift Tipsters

Lange Lift has developed basic tipster designs and frameworks that can be customized to meet your unique lifting, transfer, and dumping needs. We offer engineering services for complete ergonomic system design.

## Features:

- Customization to match your existing carts, containers, baskets, barrels, or boxes
- Tipping angles at 45°, 90°, 120°, or 135°
- Models with capacities from 500 to 50,000 lbs.



Single Cylinder Tipster

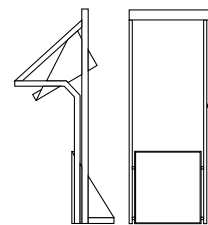
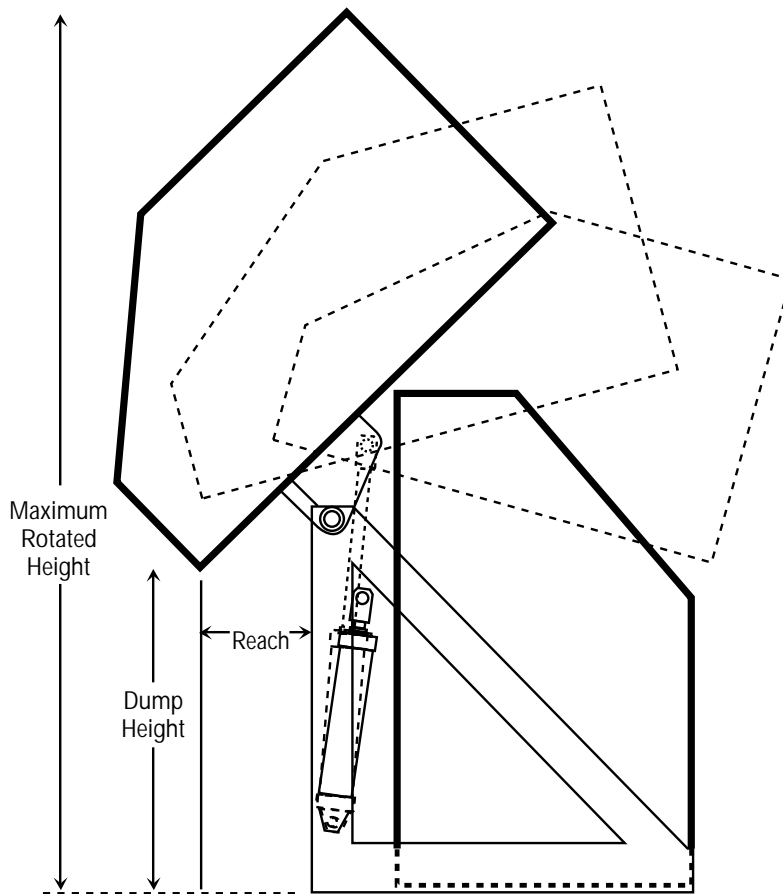

Hi-Lift Tipster

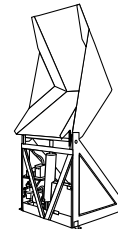

Dumper

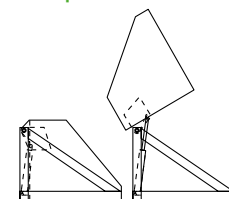

Double Cylinder Tipster

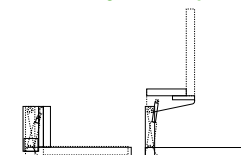

Box Unloader/Tilter

**Call today to discuss your custom Tipster needs!**

# Scissors Lifts

Lange Lift specializes in designing custom scissors lifts to meet the exact specifications of your material handling projects. When standard model scissors lifts do not meet your project requirements, have our engineers design a scissors lift that's right for the job.

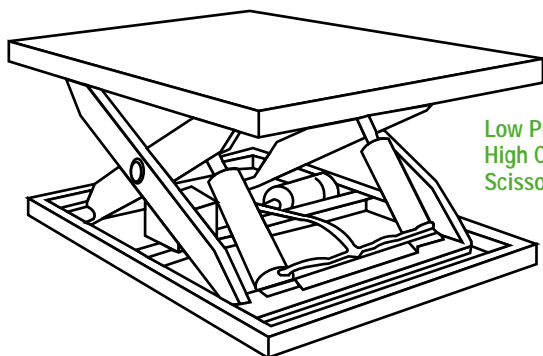

Low Profile, High Capacity Scissors Lift

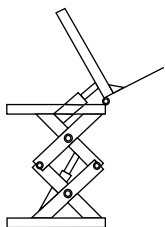

Scissors Lift with Tilt Top

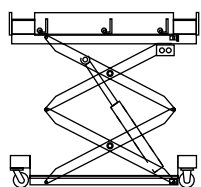

Double Scissors Lift

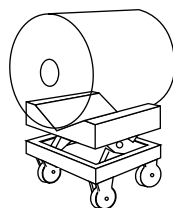

Roll Handling Scissors Lift



Super Heavy Duty Scissors Lift

## Available With:

- Safety Skirts
- Conveyor Tops
- Ball Transfer Tops
- Push-Button Control Unit
- Electric Power
- Pneumatic Power
- Battery Power

# Lange Lift Tipsters

Lange Lift has developed basic tipster designs and frameworks that can be customized to meet your unique lifting, transfer, and dumping needs. We offer engineering services for complete ergonomic system design.

## Features:

- Customization to match your existing carts, containers, baskets, barrels, or boxes
- Tipping angles at 45°, 90°, 120°, or 135°
- Models with capacities from 500 to 50,000 lbs.



Single Cylinder Tipster

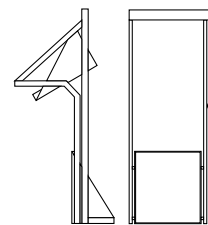
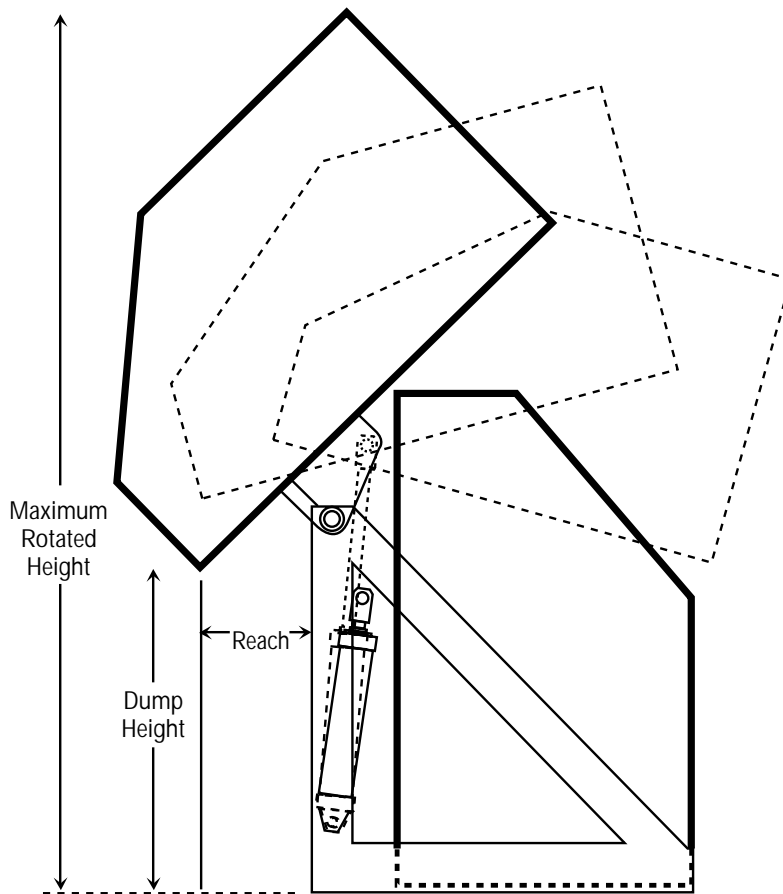

Hi-Lift Tipster

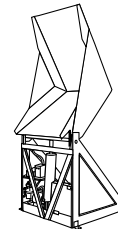

Dumper

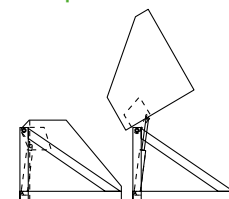

Double Cylinder Tipster

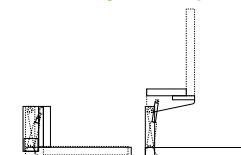

Box Unloader/Tilter

**Call today to discuss your custom Tipster needs!**

# Scissors Lifts

Lange Lift specializes in designing custom scissors lifts to meet the exact specifications of your material handling projects. When standard model scissors lifts do not meet your project requirements, have our engineers design a scissors lift that's right for the job.

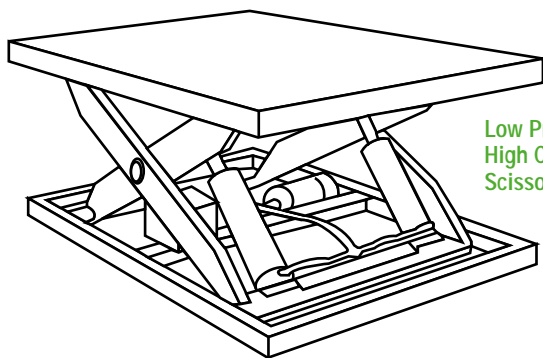

Low Profile, High Capacity Scissors Lift

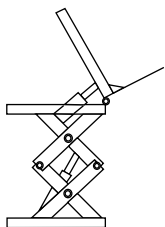

Scissors Lift with Tilt Top

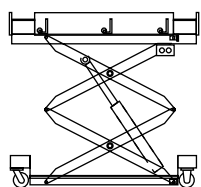

Double Scissors Lift

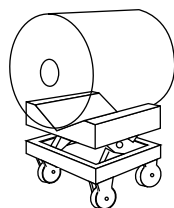

Roll Handling Scissors Lift



Super Heavy Duty Scissors Lift

## Available With:

- Safety Skirts
- Conveyor Tops
- Ball Transfer Tops
- Push-Button Control Unit
- Electric Power
- Pneumatic Power
- Battery Power

# Lange Lift Die Tables

Lange Lift's unbeatable Die Tables take the punishment under high-cycle conditions, providing practical solutions to your material handling needs. The ultimate in stability!

	Model	Capacity	Weight	Dimensions/ Deck Size
1000 Series	L-124	1,000	285 lbs.	24" x 24"
	L-130	1,000	310 lbs.	30" x 30"
	L-136	1,000	365 lbs.	36" x 36"
	L-148	1,000	450 lbs.	48" x 48"
2000 Series	L-224	2,000	300 lbs.	24" x 24"
	L-230	2,000	325 lbs.	30" x 30"
	L-236	2,000	390 lbs.	36" x 36"
	L-248	2,000	475 lbs.	48" x 48"
3000 Series	L-324	3,000	350 lbs.	24" x 24"
	L-330	3,000	385 lbs.	30" x 30"
	L-336	3,000	440 lbs.	36" x 36"
	L-348	3,000	525 lbs.	48" x 48"
4000 Series	L-424	4,000	385 lbs.	24" x 24"
	L-430	4,000	435 lbs.	30" x 30"
	L-436	4,000	490 lbs.	36" x 36"
	L-448	4,000	575 lbs.	48" x 48"

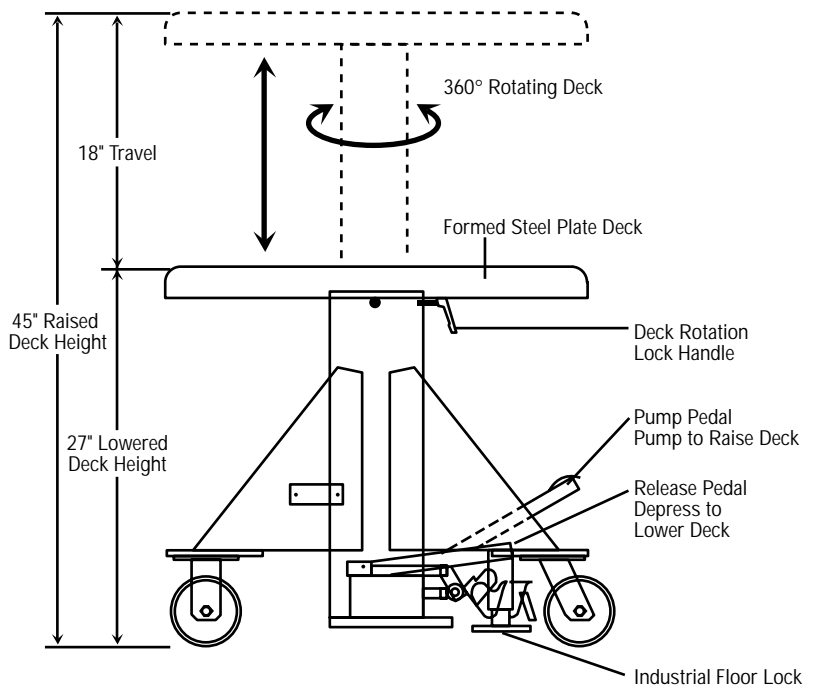

## Features:

- Reinforced steel deck
- 360° rotation, lock deck in any position at any height
- Push button adjustable lock handle
- Industrial strength floor lock keeps table in position on uneven floors
- Formed and welded leg construction
- Hydraulic foot pump
- Rugged 5" cast iron casters (2 rigid and 2 swivel) handle even the toughest loads
- Standard capacities from 1,000 to 4,000 lbs.

Capacities from 5,000 - 10,000 Available!



Standard Die Table

## Available With:

- Electric Power
- Pneumatic Power
- Battery Power

# Modified Die Tables

Every job is different. All Lange Lift Die Tables can be modified to fit your particular application and environment. The possibilities are endless!

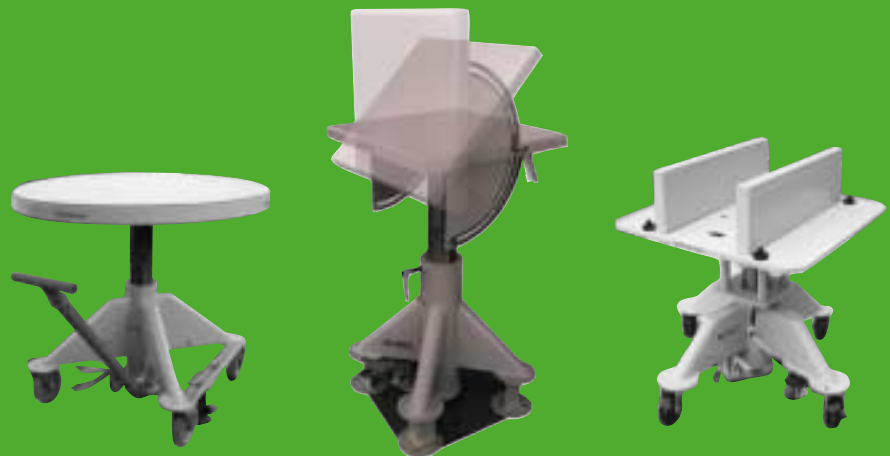
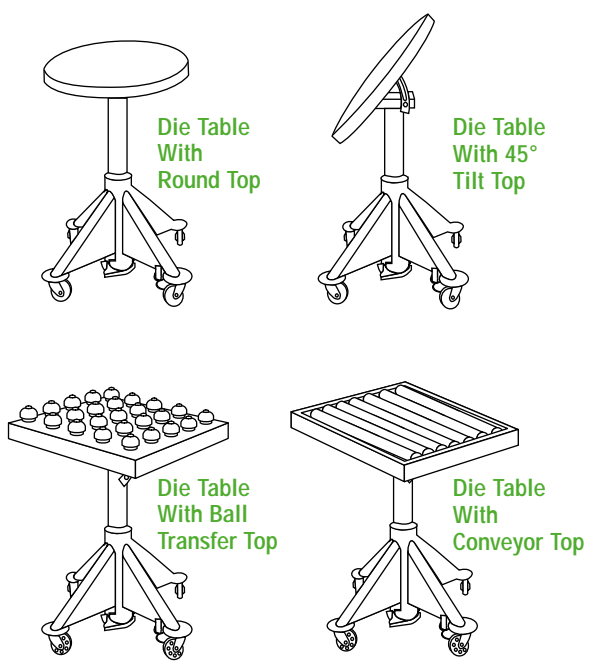

Die Table With Tow Handle      Die Table With Tilt Top      Custom Die Table

CALL WITH YOUR CUSTOM REQUIREMENTS!

1-800-558-0577

www.langelift.com



# Lange Lift Custom Lift Systems

Our experienced engineers will work closely with you in designing and building a custom lift system which meets your unique requirements.

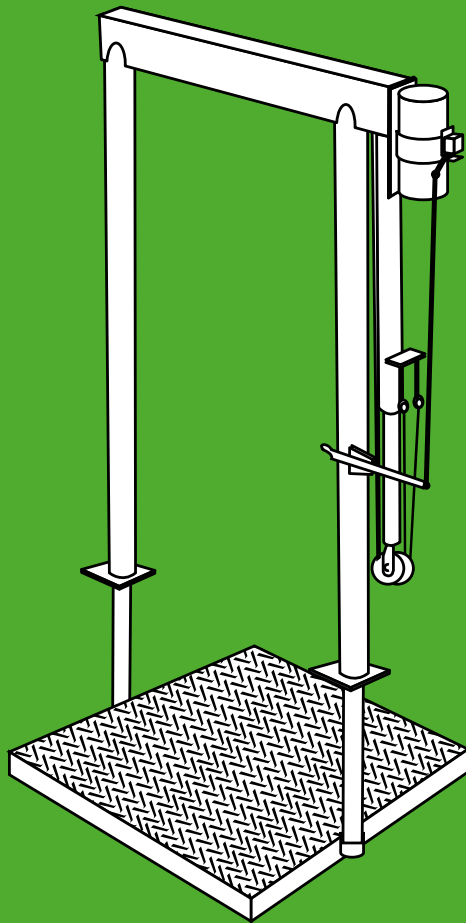

Dorway® Lift

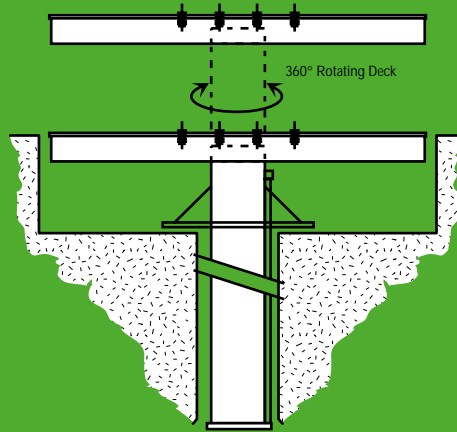

In-Ground Lift



Dual-Post Lift

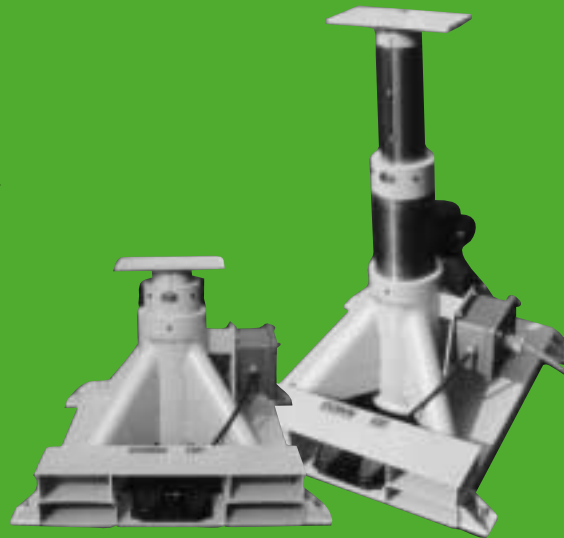

Telescopic Cylinder Lift



**CALL TODAY FOR YOUR QUOTE!**

**1-800-558-0577**

[www.langelift.com](http://www.langelift.com)

N90 W14555 Commerce Dr.  
PO Box 580 (53052)  
Menomonee Falls, WI 53051

Phone: 262-502-0333  
Fax: 262-502-0260

## Warranty Terms

Lange Lift warrants its products to be free of defects in materials or workmanship. Lange Lift makes no other warranties, expressed or implied, including no warranties of fitness for particular purpose. Lange Lift's obligations under this warranty shall be limited to repair or replacement of the products in question or, at its sole option,

refund of the purchase price; Lange Lift disclaims any liability for incidental or consequential damages, including liability for lost profits. This warranty shall be voided by any misuse or abuse of the product, or upon any modification of the products without Lange Lift's prior expressed written authorization. Any claims under this warranty must be made,

in writing, within one year from date of delivery to the customer. Lange Lift's acceptance of this order is conditioned upon customer's agreement to these warranty terms. No modification of these terms shall be effective against Lange Lift unless in writing and signed by an authorized representative of Lange Lift.